



Model WSD-600

UPB Dimming Wall Switch

Features

- Stronger signal strength
- Increased electrical noise resistance
- Utilizes standard electrical wiring - retro-fits easily in existing homes
- Aesthetically pleasing packaging

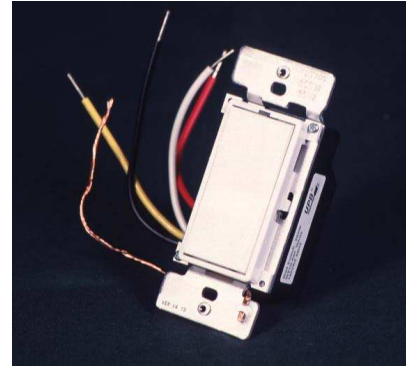

The **WSD-600 UPB Dimming Wall Switch** provides control of lighting throughout a home. The wall switch replaces standard and existing manual wall switches and provides manual, computer control, and remote control of the home's lighting system. The device is housed in an aesthetically pleasing package which mounts in one position of a standard electrical wiring box. The switch is designed to work with standard Decora style faceplates.

Each WSD-600 can be part of 16 individual links, or scenes. These scenes can be controlled through the use of the WMT NetPlace server, or through the use of multi-button controllers located throughout the home. In addition, with the use of the WMT server, the switch can be controlled based upon time of day, based upon the status of another device (i.e., a security system), or be part of a macro..

The key to the switch's function is the Universal Powerline Bus technology for communication applications. Use of standard electrical wiring for communication transmission is possible due to lower noise levels, stronger signal strength and improved reliability surpassing technologies such as X-10, CeBus and others. UPB technology also allows enough individually addressable devices to control the largest residential environment usually without the need for phase coupling and without affecting or being affected by adjacent home environments.

UPB Benefits

- Higher reliability
- Lower system cost
- Individual home selective (No crossover/interference from adjacent homes)
- Phase coupling not required except in very large homes

Applications

- Lighting control functions for whole house lighting.
- Control lighting from a remote location within the home
- Control functions based upon time/event programming when connected to Web Mountain NetPlace server

WSD-600

Dimming Wall Switch

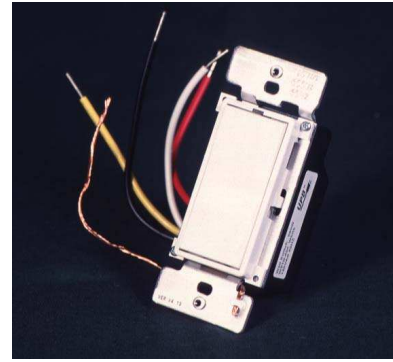

Application Drawing

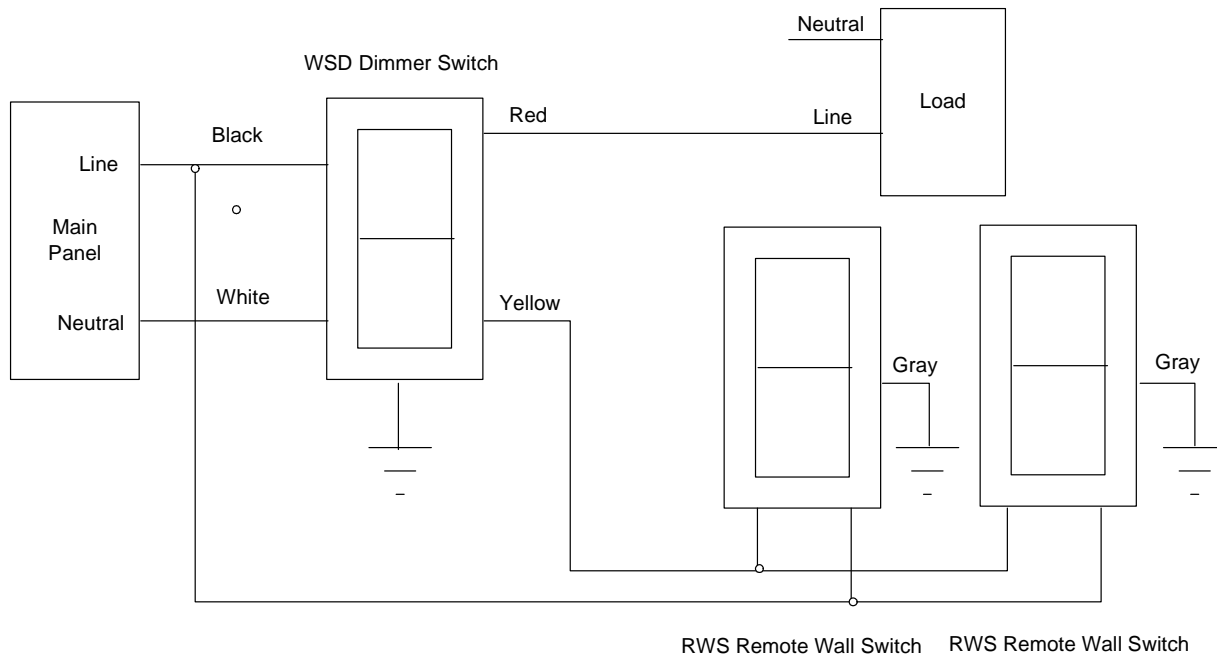

Specifications

Model Name	Dimming 600W Wall Switch
Model Number	WSD-600W (W at end defines color of plastics)
Packaging	Fits one position of standard electrical wall box—compatible with Decora Style faceplate.
Dimensions	Approx. 1.75"D X 1.625"W X 2.75"H
Net Weight	4 oz.
Protocol	UPB, as defined by PCS Lighting, Aug, 2003
Addressing	250 Network codes (House codes; prevents crossover/interference); 250 Individual device codes
Input Voltage	120V AC
Output	120V AC switched
Load Type	Incandescent lighting
Maximum Load Delivered	600W
Certifications	UL 1950
Operating Temperature	0° to +50°C, -30° to 120°F

Web Mountain Technologies, LLC

13882 E. Grand Ave., Aurora, CO 80015

Ph: 303-627-1856

Fax: 303-627-7665

www.webmtn.com

Copyright 2000, 2001 Web Mountain Technologies, LLC. All rights reserved. NetPlace and LanBuilder are trademarks of Web Mountain Technologies, LLC. X-10 is a registered trademark of X-10 PRO. Windows is a trademark of Microsoft Corporation. Linux is a trademark of Linus Torvalds. Apple is a trademark of Apple Computer, Inc. Netscape is a registered trademark of Netscape Communication Corporation. All other products and company names are trademarks of their respective holders.